

Technical datasheet

DIABLO-L-830-2-24-BL



Product description

Diablo is a compact 3-phase LED spotlight with integrated power supply and aluminum heatsink with 50,000 hours lifetime. Available in 3 power options, wide range of color temperatures (2700K-4000K) with CRI 80+/90+. Four light distribution types (15°, 24°, 36°, 60°) and DALI control option available. Ideal for commercial spaces, showrooms and households. 5-year warranty.

LED 220-240V IP20    CCT CRI 

Product technical data

Mains voltage	220 - 240V AC, 50/60Hz	Ripple	3 %
Connection method	3-phase track adapter	DALI address	1
Dimming type	DALI	Standby power	0.50 W
IP rating	20	Inrush current	5 A
Protection class	II	Inrush time	50 µs
Ambient temperature	0 to +25 °C	Optical system	Lenses
Light source	LED	Optical part material	PMMA
Colour temperature	3000k	Housing material	Die-cast aluminium
Color rendering index	80	Surface finish	Powder coated
Rated luminous flux	3,768 lm	Height	132.00 cm
Connected load	27.58 W	Diameter	90.00 cm
Luminous efficacy	136.6 lm/W	Weight	0.80 kg
		Service lifetime (L80 B10)	50 000 h
		Warranty	5 years

Dimensions

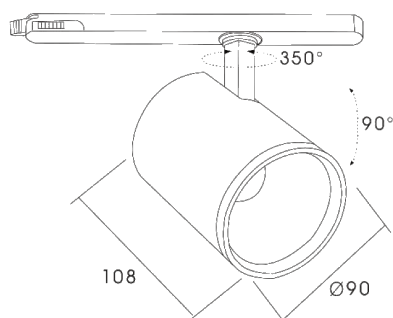

Light distribution

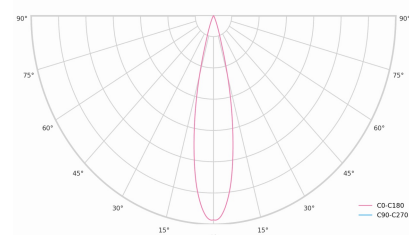

Optional products



PRO-0410



PRO-0420



PRO-0431L



PRO-0431R



PRO-0432



PRO-0433



PRO-0434



PRO-0437



PRO-EZ0449



PRO-M435



PRO-M436



PRO-M438

DALI 2

DALI (Digital Addressable Lighting Interface) is an international standard for digital lighting control systems. It enables individual control of each luminaire in the network using digital signals - unlike traditional analog solutions.

Key DALI2 innovations:

- Advanced diagnostic capabilities
- Better fault reporting and device status
- Enhanced scene programming options
- Support for RGB/RGBW and tunable white