

Technical datasheet

DIABLO-S-930-1-60-WH



Product description

Diablo is a compact 3-phase LED spotlight with integrated power supply and aluminum heatsink with 50,000 hours lifetime. Available in 3 power options, wide range of color temperatures (2700K-4000K) with CRI 80+/90+. Four light distribution types (15°, 24°, 36°, 60°) and DALI control option available. Ideal for commercial spaces, showrooms and households. 5-year warranty.

LED 220-240 V IP20    CCT CRI
 50-60Hz 3000 k 90+

Product technical data

Mains voltage	220 - 240V AC, 50/60Hz
Connection method	3-phase track adapter
Dimming type	Non-dimmable
IP rating	20
Protection class	II
Ambient temperature	0 to +25 °C
Light source	LED
Colour temperature	3000k
Color rendering index	90
Rated luminous flux	1,808 lm
Connected load	13.58 W
Luminous efficacy	133.1lm/W

Ripple	5 %
Inrush current	7 A
Inrush time	28 μs
Optical system	Lenses
Optical part material	PMMA
Housing material	Die-cast aluminium
Surface finish	Powder coated
Height	132.00 cm
Diameter	90.00 cm
Weight	0.80 kg
Service lifetime (L80 B10)	50 000 h
Warranty	5 years

Dimensions

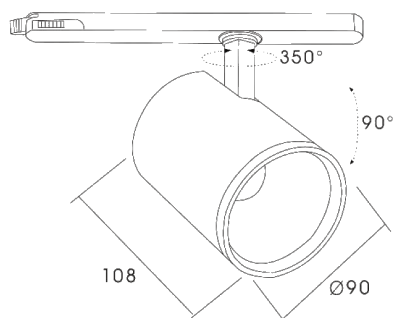

Light distribution

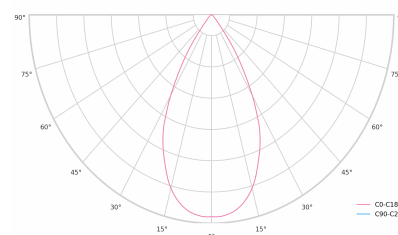

Optional products



PRO-0410



PRO-0420



PRO-0431L



PRO-0431R



PRO-0432



PRO-0433



PRO-0434



PRO-0437



PRO-EZ0449



PRO-M435



PRO-M436



PRO-M438