

Technical datasheet

LUKA-XL-740-1-C13300



Product description

Luka emits reliably efficient light on traffic roads and industrial areas to support safety and security outdoors. The smart function also offers a range of smart city functions.

LED 220-240V 50-60Hz **IP66** **CE** **CCT 4000 k** **CRI 70+** **CLO**

Product technical data

| | |
|-----------------------|------------------------|
| Mains voltage | 220 - 240V AC, 50/60Hz |
| Connection method | Connection cable |
| Dimming type | Non-dimmable |
| IP rating | 66 |
| Protection class | I |
| Ambient temperature | -40 to +40 °C |
| Light source | LED |
| Colour temperature | 4000k |
| Color rendering index | 70 |
| Rated luminous flux | 6,675 lm |
| Connected load | 56.50 W |
| Luminous efficacy | 118.1 lm/W |

| | |
|----------------------------|--------------------|
| Ripple | 3 % |
| Inrush current | 85 A |
| Inrush time | 256 μs |
| Optical system | Lenses |
| Optical part material | Hardened glass |
| Housing material | Die-cast aluminium |
| Surface finish | Powder coated |
| Service lifetime (L80 B10) | >100 000 h |
| Warranty | 5 years |

Dimensions

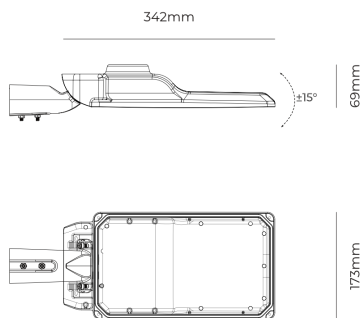

Light distribution

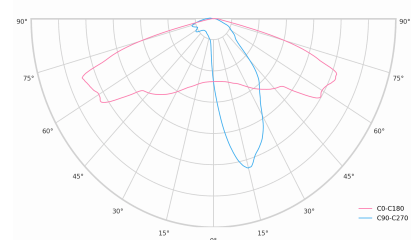

Constant Light Output (CLO)

This system compensates for the depreciation of luminous flux to avoid excess lighting at the beginning of the installation's service life. Luminous depreciation over time must be taken into account to ensure a predefined lighting level during the luminaire's useful life.

Without a CLO feature, this simply means increasing the initial power upon installation in order to make up for luminous depreciation. By precisely controlling the luminous flux, the energy needed to reach the required level can be maintained throughout the luminaire's life.



A. Dimming level
B. Time

MidNight function

The MidNight function feature allows an autonomous dimming without the need for an additional control line. The output levels can be set to 0% (OFF) or between 10% and 100% in steps of 1%.

Time-based: The dimming profile defined in the reference schedule is referenced to the switch-on time of the LED driver.

Astro-based: The dimming profile defined in the reference schedule is referenced to the annual average middle of the night, which is calculated based on the theoretical sunrise and sunset times.



1. Standard lighting level
2. LED lighting consumption with CLO
3. Energy savings