

Technical datasheet

LUKA-XL-730-1-C14680



Product description

Luka emits reliably efficient light on traffic roads and industrial areas to support safety and security outdoors. The smart function also offers a range of smart city functions.

LED 220-240V 50-60Hz **IP66** **CE** **CCT 3000 k** **CRI 70+** **CLO**

Product technical data

Mains voltage	220 - 240V AC, 50/60Hz
Connection method	Connection cable
Dimming type	Non-dimmable
IP rating	66
Protection class	I
Ambient temperature	-40 to +40 °C
Light source	LED
Colour temperature	3000k
Color rendering index	70
Rated luminous flux	6,394 lm
Connected load	56.50 W
Luminous efficacy	113.2 lm/W

Ripple	3 %
Inrush current	85 A
Inrush time	256 µs
Optical system	Lenses
Optical part material	Hardened glass
Housing material	Die-cast aluminium
Surface finish	Powder coated
Service lifetime (L80 B10)	>100 000 h
Warranty	5 years

Dimensions

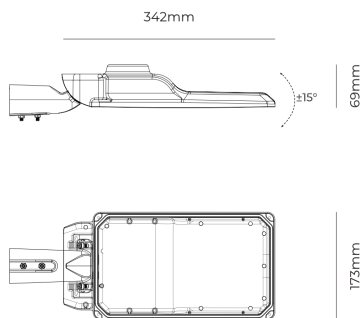

Light distribution

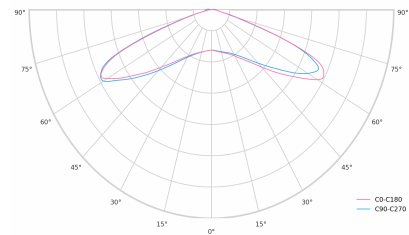

Constant Light Output (CLO)

This system compensates for the depreciation of luminous flux to avoid excess lighting at the beginning of the installation's service life. Luminous depreciation over time must be taken into account to ensure a predefined lighting level during the luminaire's useful life.

Without a CLO feature, this simply means increasing the initial power upon installation in order to make up for luminous depreciation. By precisely controlling the luminous flux, the energy needed to reach the required level can be maintained throughout the luminaire's life.



A. Dimming level
B. Time

MidNight function

The MidNight function feature allows an autonomous dimming without the need for an additional control line. The output levels can be set to 0% (OFF) or between 10% and 100% in steps of 1%.

Time-based: The dimming profile defined in the reference schedule is referenced to the switch-on time of the LED driver.

Astro-based: The dimming profile defined in the reference schedule is referenced to the annual average middle of the night, which is calculated based on the theoretical sunrise and sunset times.



1. Standard lighting level
2. LED lighting consumption with CLO
3. Energy savings